

# XN-9 series

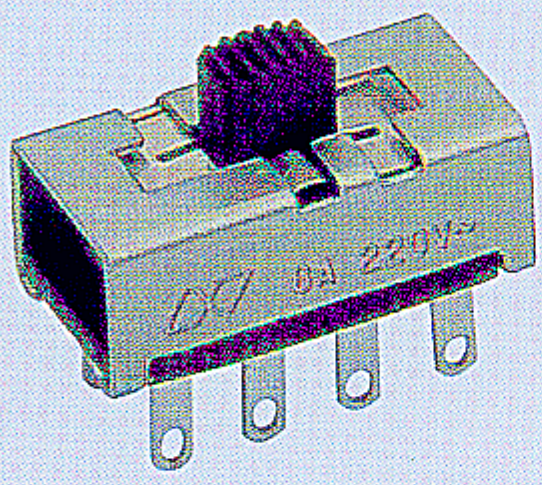

- Single/double pole; Single/double throw
- Ratings:  
9A 125VAC; 4.5A 250VAC
- Features:  
Knob terminal & casing options see selections guide

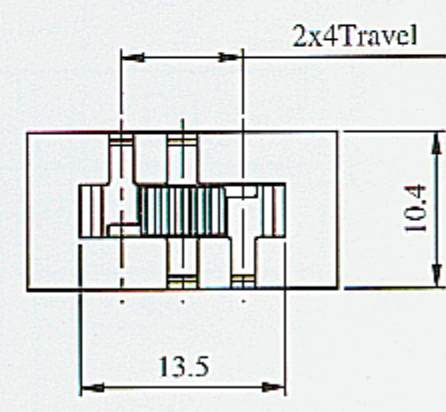
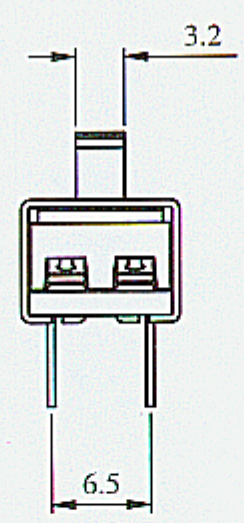
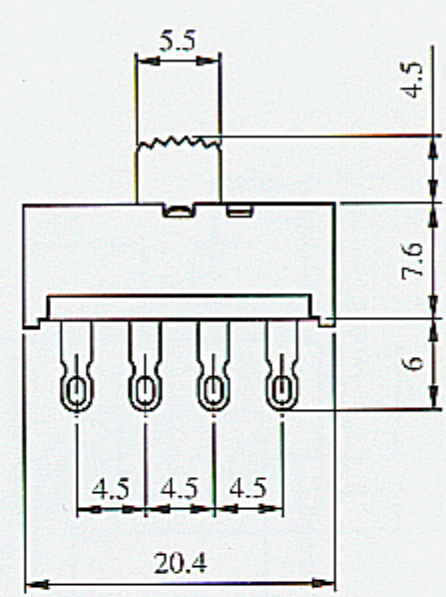

### Circuit diagram

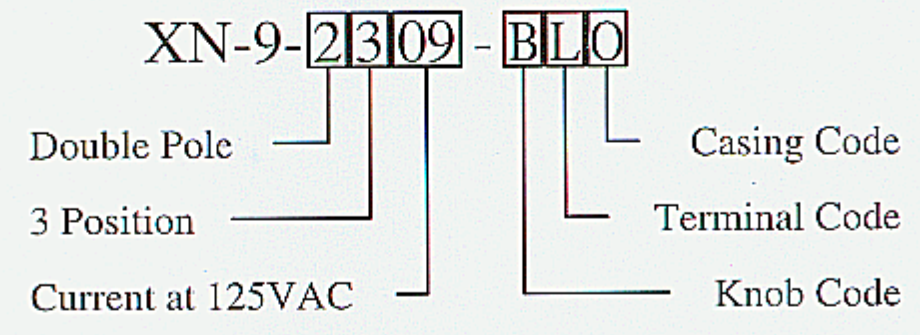
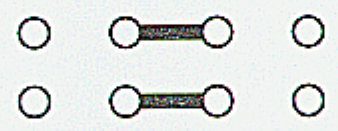

### 拨块代码 (Knob Options)

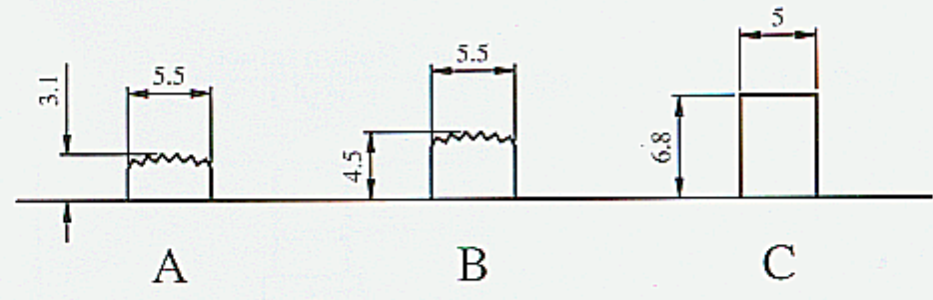

### 端子代码 (Terminal Options)

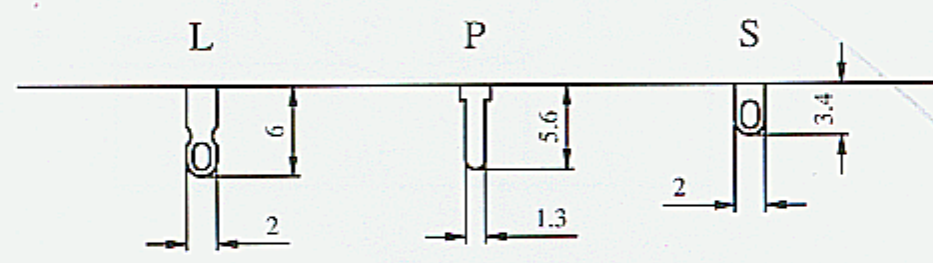

### 外壳代码 (Casing Options)

